

# 1146 46 Ascendant Series Caster Series(All Plastic)



Double-Ball Full-Effect Wheel (White-Dark Gray with Large Wheel Cover) Wheel  
 Diameter × Wheel Width

EAN

KS-11460500454173

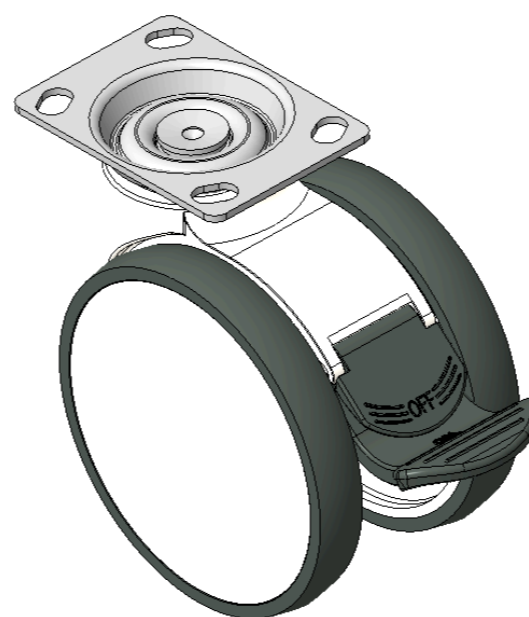

Picture may differ from original product

Drawings are for reference only and may differ from the product

## Technical Data

Metric  Imperial

Wheel Diameter	125mm
Wheel Width	85.5mm
Wheel Bearing	Wheels With Ball Bearings
Plate Size	96 x 69mm
Bolt Hole Spacing	74.5 x 49mm
Plate Hole	10 x 15mm
Offset	40mm
Swivel Interference	282mm
Overall Height	147mm
Swivel Radius	141mm
Hardness Of Tread	72±5° Shore A
Load Capacity (Dynamic)	110kgs
Load Capacity (Static)	165kgs
Temperature	-20°C to +60°C
Fork Type	Swivel Caster With Total Brake
Stainless	N/A
Electrical Conductivity	N/A
Anti-Static	N/A
Weight	0.85kgs
Standard	ISO22881

## Advantages at a glance

Rolling Resistance	●●●●●
Operating Noise	●●●●●
Floor Surface Preservation	●●●●●

## Dimensions

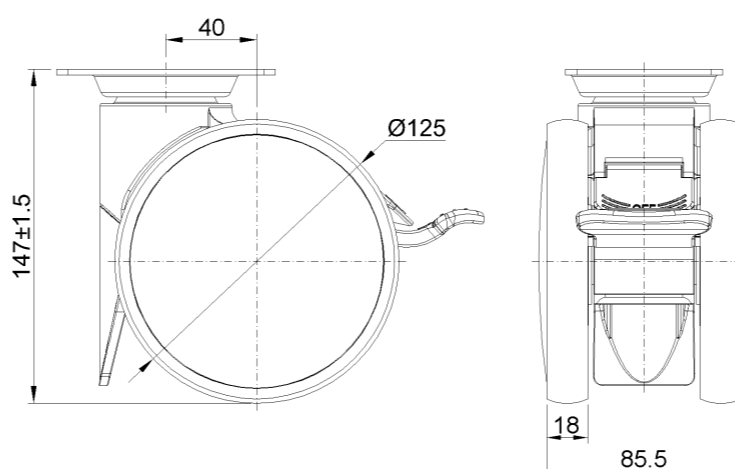

## Mounting

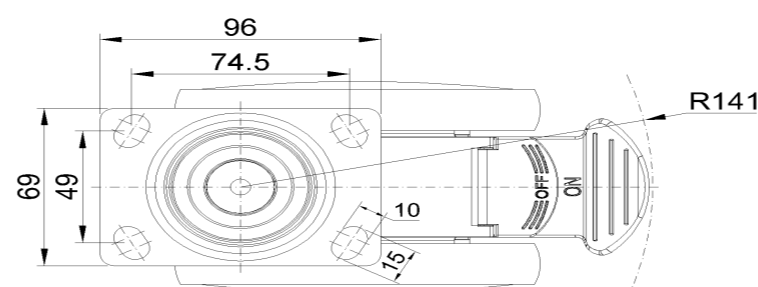

\* For any deviation between metric and imperial spec, please refer to the metric spec.