

1146 46 Ascendant Series Caster Series(All Plastic)



Double-Ball Full-Effect Wheel (White-Dark Gray) Wheel Diameter × Wheel Width 125 × 18mm

EAN

KS-11460500454553

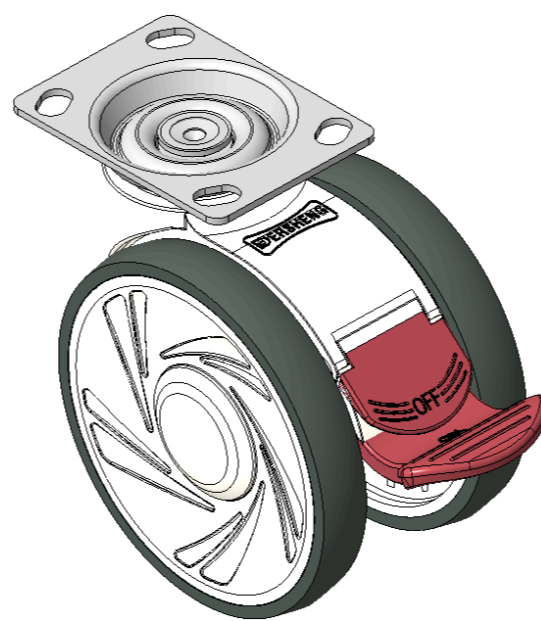

Picture may differ from original product

Drawings are for reference only and may differ from the product

Technical Data

Metric Imperial

| | |
|-------------------------|--------------------------------|
| Wheel Diameter | 125mm |
| Wheel Width | 85.5mm |
| Wheel Bearing | Wheels With Ball Bearings |
| Plate Size | 96 x 69mm |
| Bolt Hole Spacing | 74.5 x 49mm |
| Plate Hole | 10 x 15mm |
| Offset | 40mm |
| Swivel Interference | 282mm |
| Overall Height | 144mm |
| Swivel Radius | 141mm |
| Hardness Of Tread | 72±5° Shore A |
| Load Capacity (Dynamic) | 110kgs |
| Load Capacity (Static) | 165kgs |
| Temperature | -20°C to +60°C |
| Fork Type | Swivel Caster With Total Brake |
| Stainless | N/A |
| Electrical Conductivity | N/A |
| Anti-Static | N/A |
| Weight | 0.85kgs |
| Standard | ISO22881 |

Advantages at a glance

| | |
|----------------------------|-------|
| Rolling Resistance | ●●●●● |
| Operating Noise | ●●●●● |
| Floor Surface Preservation | ●●●●● |

Dimensions

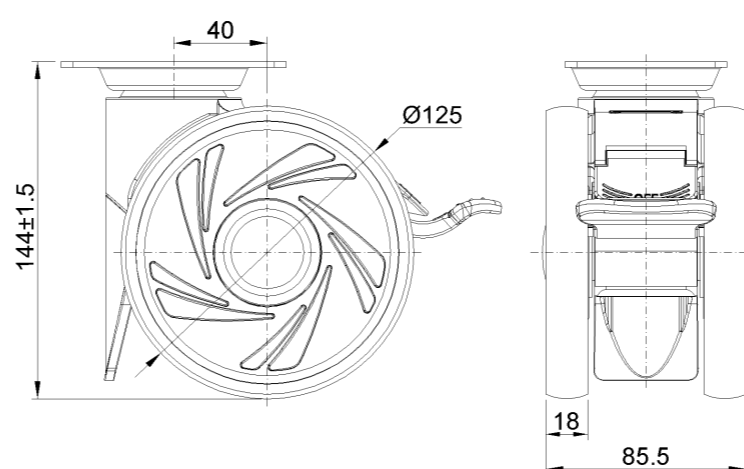

Mounting

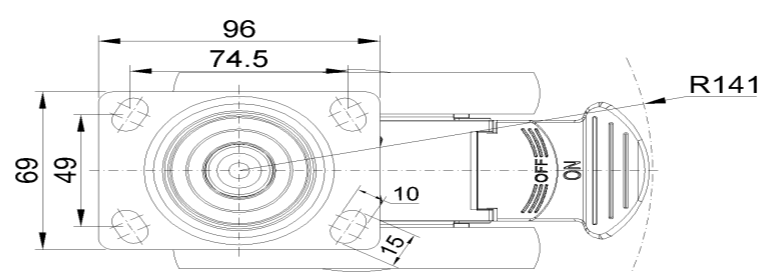

* For any deviation between metric and imperial spec, please refer to the metric spec.