

1116-SS-MI Medium Duty Institutional Stainless Steel Caster Series



PPR wheel (pearl dark gray) Wheel diameter × wheel width 75 x 31mm

EAN

TW-4111603004108

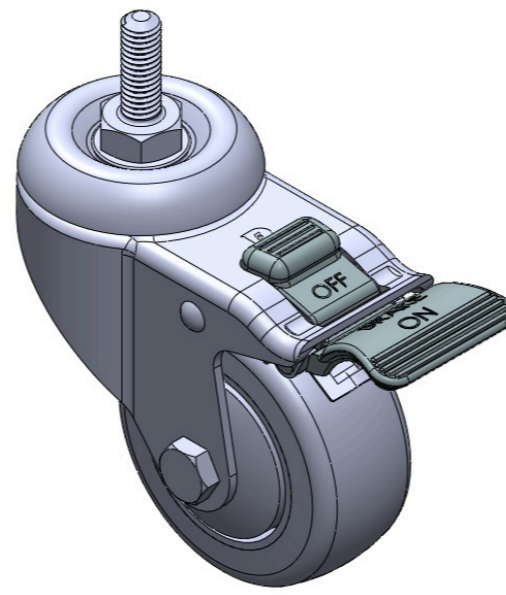

Drawings are for reference only and may differ from the product

Picture may differ from original product

Technical Data

Metric Imperial

Wheel Diameter	75mm
Wheel Width	31mm
Wheel Bearing	Wheels With Ball Bearings
Threaded Stem	3/8" -16牙
Threaded Length	28mm
Offset	41.5mm
Swivel Interference	212mm
Overall Height	109mm
Swivel Radius	106mm
Hardness Of Tread	82±5° Shore A
Load Capacity (Dynamic)	90kgs
Load Capacity (Static)	135kgs
Temperature	-20°C to +60°C
Fork Type	Swivel Caster With Total Brake
Stainless	Y
Electrical Conductivity	N/A
Anti-Static	N/A
Weight	0.65kgs
Standard	ISO22883

Advantages at a glance

Rolling Resistance	● ● ● ● ○
Operating Noise	● ● ● ● ○
Floor Surface Preservation	● ● ● ● ●

Dimensions

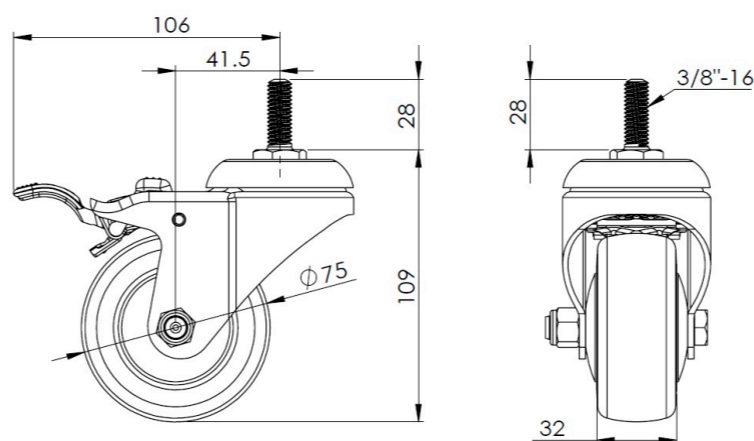

Mounting

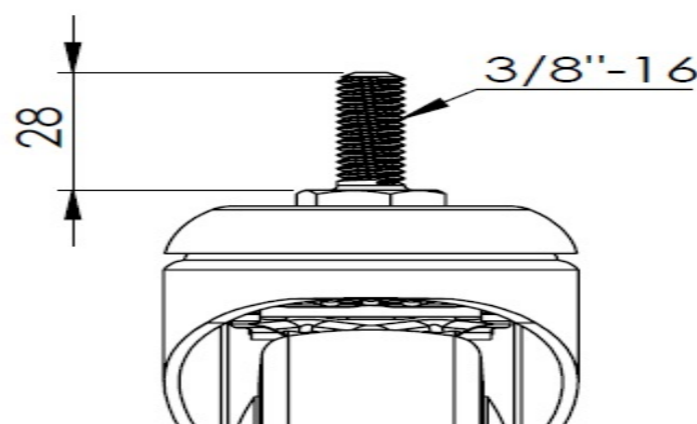

* For any deviation between metric and imperial spec, please refer to the metric spec.