

# 1116-SS-MI Medium Duty Institutional Stainless Steel Caster Series



PPR wheel (pearl dark gray) Wheel diameter × wheel width 75 x 31mm

EAN

TW-4111603004108

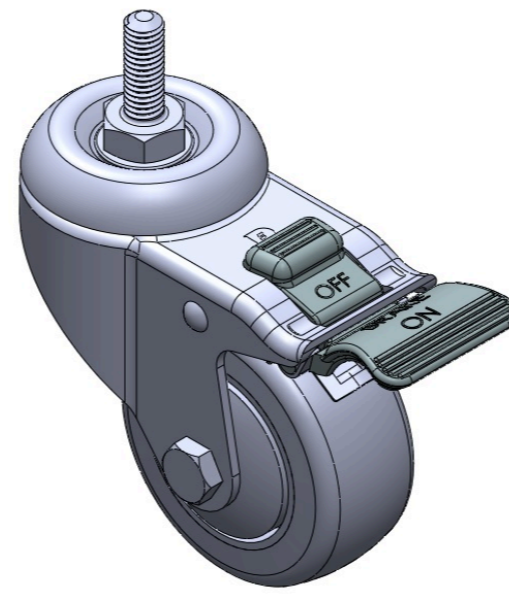

Drawings are for reference only and may differ from the product

Picture may differ from original product

## Technical Data

Imperial  Metric

Wheel Diameter	3 "
Wheel Width	1-1/4 "
Wheel Bearing	Wheels With Ball Bearings
Threaded Stem	3/8 " -16牙
Threaded Length	1-1/8 "
Offset	1-11/16 "
Swivel Interference	8-1/2 "
Overall Height	4-3/8 "
Swivel Radius	4-1/4 "
Hardness Of Tread	82±5° Shore A
Load Capacity (Dynamic)	198lbs
Load Capacity (Static)	298lbs
Temperature	-4°F to +140°F
Fork Type	Swivel Caster With Total Brake
Stainless	Y
Electrical Conductivity	N/A
Anti-Static	N/A
Weight	1.4lbs
Standard	ISO22883

## Advantages at a glance

Rolling Resistance	● ● ● ● ○
Operating Noise	● ● ● ● ○
Floor Surface Preservation	● ● ● ● ●

## Dimensions

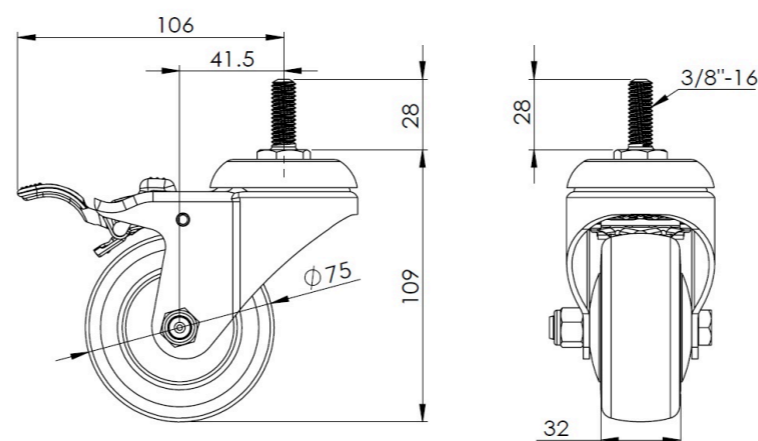

## Mounting

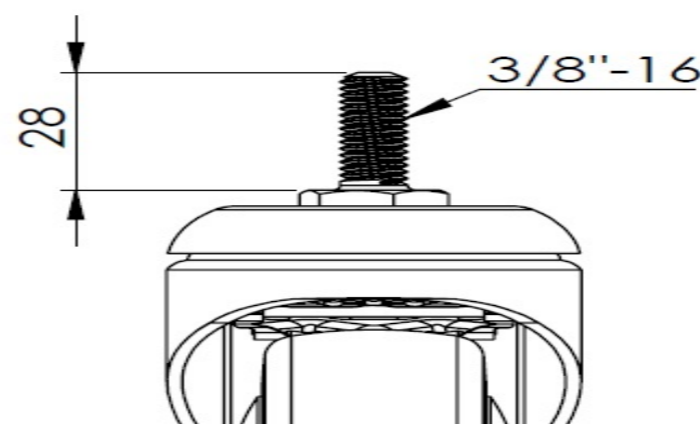

\* For any deviation between metric and imperial spec, please refer to the metric spec.