

1116-SS-MI Medium Duty Institutional Stainless Steel Caster Series



W Resolute Wheel Diameter × Wheel Width 100 x 31mm

EAN

TW-4111604004033

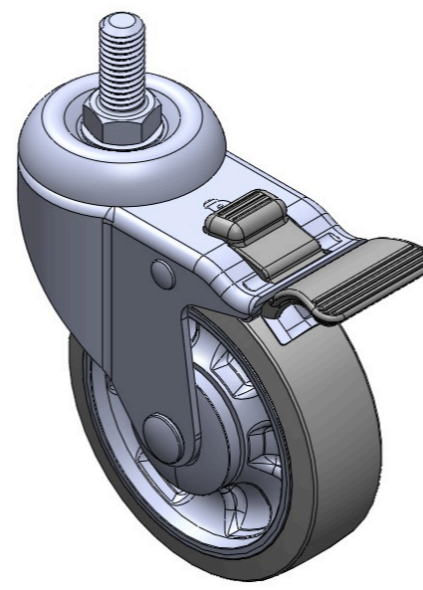

Drawings are for reference only and may differ from the product

Picture may differ from original product

Technical Data

Metric Imperial

Wheel Diameter	100mm
Wheel Width	31mm
Wheel Bearing	Wheels With Ball Bearings
Threaded Stem	1/2" -12
Threaded Length	28mm
Offset	41mm
Swivel Interference	210mm
Overall Height	134mm
Swivel Radius	105mm
Hardness Of Tread	72±5° Shore A
Load Capacity (Dynamic)	135kgs
Load Capacity (Static)	202.5kgs
Temperature	-20°C to +60°C
Fork Type	Swivel Caster With Total Brake
Stainless	Y
Electrical Conductivity	N/A
Anti-Static	N/A
Weight	0.75kgs
Standard	ISO22883

Advantages at a glance

Rolling Resistance	●●●●●
Operating Noise	●●●●●
Floor Surface Preservation	●●●●●

Dimensions

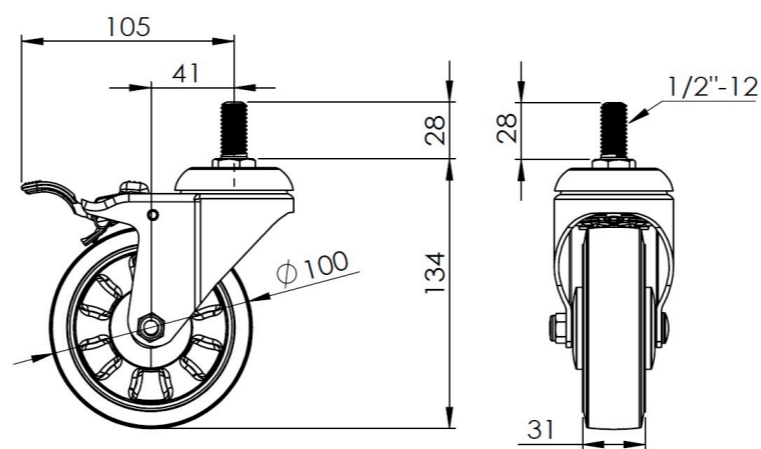

Mounting

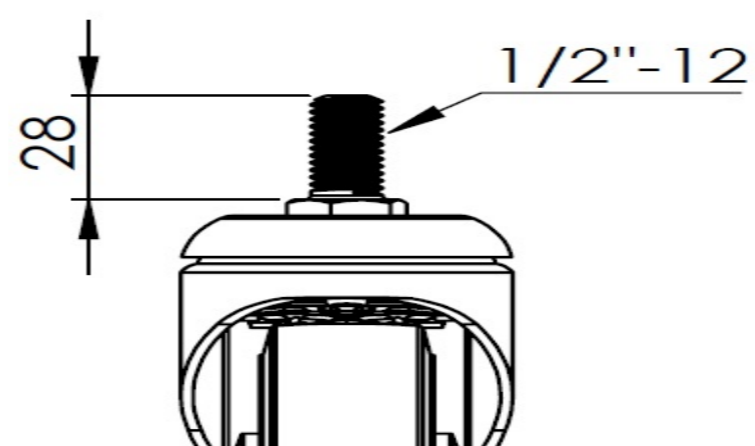

* For any deviation between metric and imperial spec, please refer to the metric spec.