

1116-SS-MI Medium Duty Institutional Stainless Steel Caster Series



WMRC Wheel Diameter × Wheel Width 100 x 31mm

EAN

TW-4111604004045

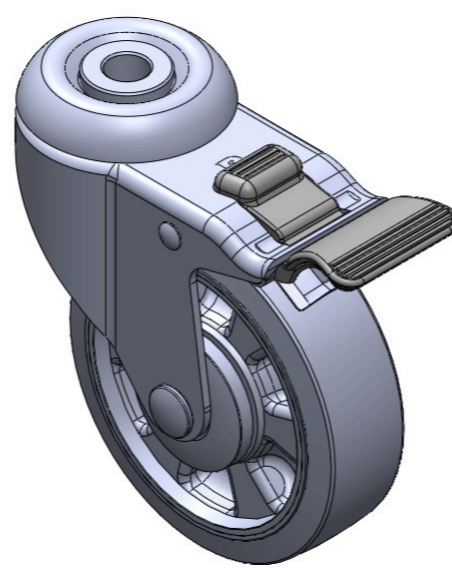

Drawings are for reference only and may differ from the product

Picture may differ from original product

Technical Data

Imperial Metric

Wheel Diameter	4 "
Wheel Width	1-1/4 "
Wheel Bearing	Wheels With Ball Bearings
Single Bolt Hole Centre Hole	1/2 "
Offset	1-5/8 "
Swivel Interference	8-3/8 "
Overall Height	5-1/8 "
Swivel Radius	4-3/16 "
Hardness Of Tread	75±5° Shore D
Load Capacity (Dynamic)	298lbs
Load Capacity (Static)	446lbs
Temperature	-4°F to +176°F
Fork Type	Swivel Caster With Total Brake
Stainless	Y
Electrical Conductivity	N/A
Anti-Static	N/A
Weight	1.4lbs
Standard	ISO22883

Advantages at a glance

Rolling Resistance	●●●●●
Operating Noise	●●○○○
Floor Surface Preservation	●●○○○

Dimensions

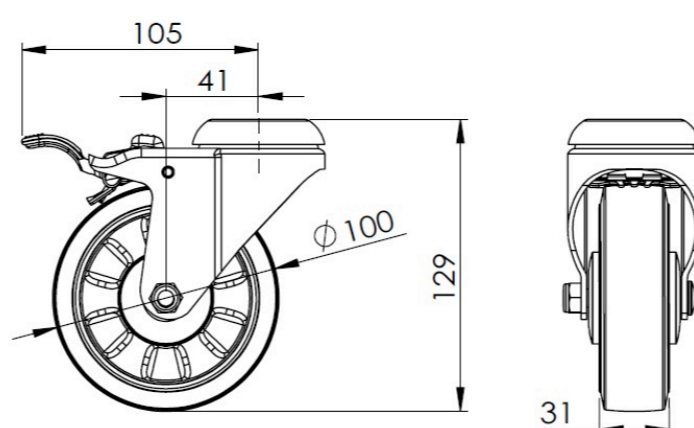

Mounting

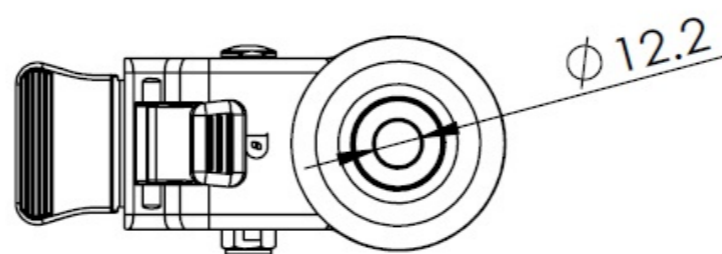

* For any deviation between metric and imperial spec, please refer to the metric spec.

© Copyright 2026 DershengInternational www.dersheng.com